

H G F E D C B A

4

3

2

1

4

3

2

1

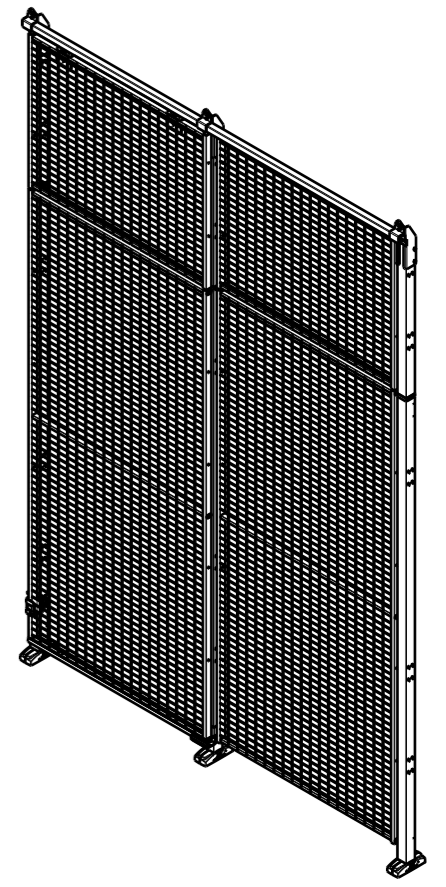
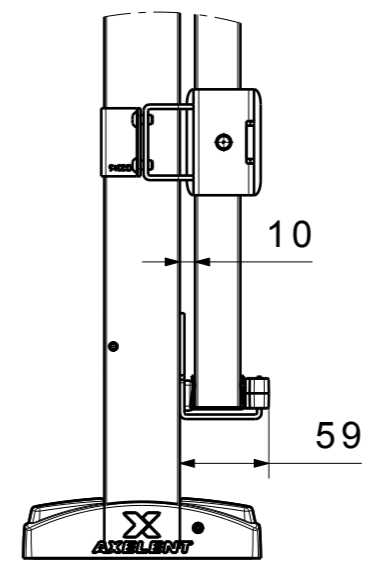
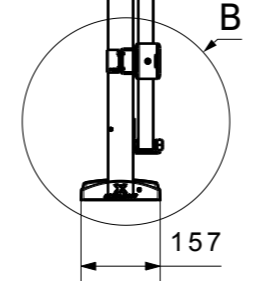
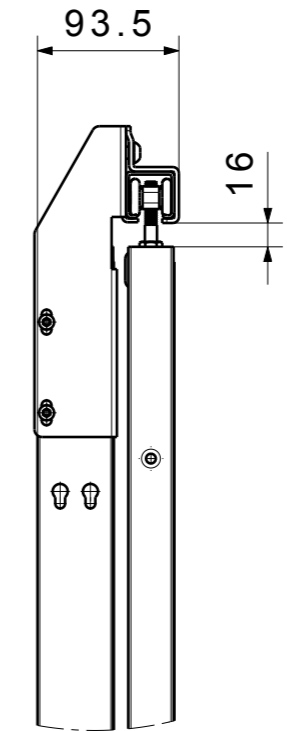
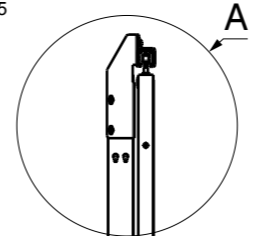
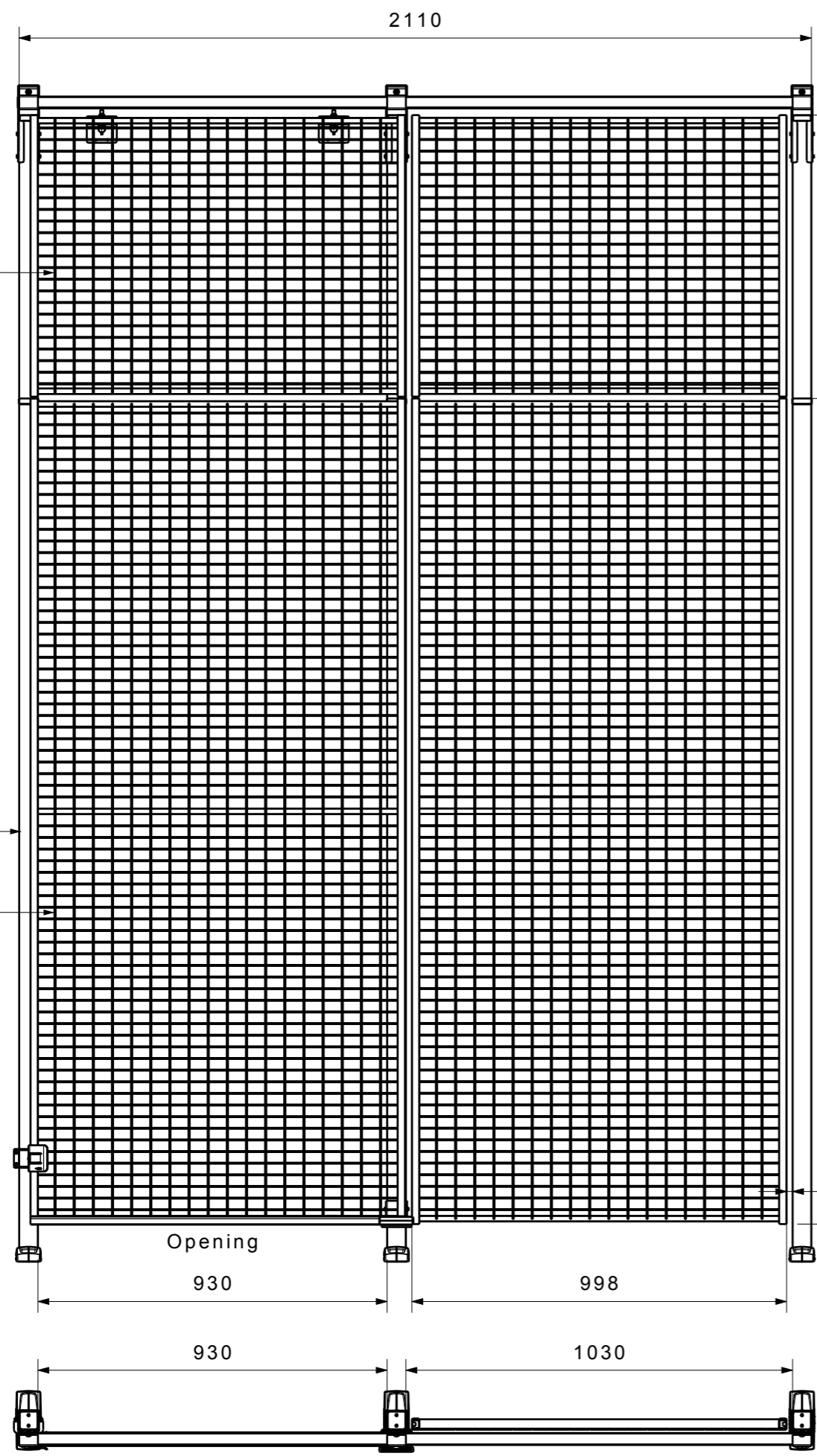

Item No.	Name	Quantity
1	322-220100	2
2	P11-230	3
3	322-075100	2



Title
D20-XXX100B

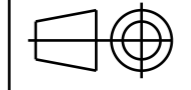

Scale
1:15

Rev.
--A

Date
4/4/2013

H G F E D C B A